

Spielturm-Kombination

Gerätelinie Robinie











Artikel 42505

Spielturm-Kombination aus chemisch unbehandeltem Robinienkernholz geschliffen, Podesthöhe 150 cm, mit Satteldach, Sprossenaufstieg, Kletternetzaufstieg, Rutschbahn aus Polyester grau/anthrazit und Schaukelabteil für einen Sitz.



CHF 10'680.-

(exkl. MWST)

 Altersgruppe	3+
 Gerätemasse	729 x 407 x 349 cm
 Platzbedarf	879 x 846 cm
 min. Aufprallfläche	48,8 m ²
 Fallhöhe	150 cm
 schwerstes Element	390 kg
 grösstes Element	428 x 150 x 150 cm
 Fundamente	9
 Beton	1,35 m ³
 Montagezeit	4 h
 Monteure	2

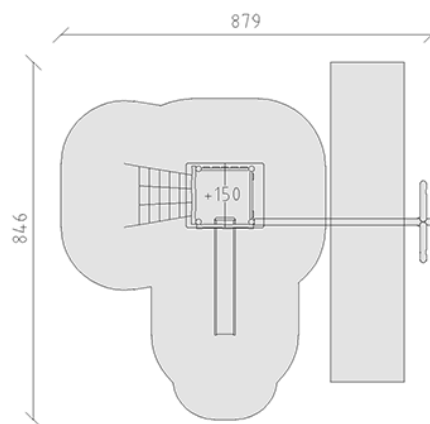

buerli
Mitten im Spiel

+41 41 925 14 00

info@buerli.swiss