

# Balancierkahn gross

Gerätelinie Robinie











Artikel 43985

Balancierkahn aus chemisch unbehandeltem Robinienkernholz geschliffen, Podesthöhe 180 cm, mit Pultdach, Sprossenaufstieg, Schrägaufstieg, verdrehte Leiter, Rutschbahn aus Polyester rot/anthrazit und Balancier-Parcours.



**CHF 34'435.-**

(exkl. MWST)

	Altersgruppe	3+
	Gerätemasse	1391 x 505 x 425 cm
	Platzbedarf	1745 x 825 cm
	min. Aufprallfläche	51.8 m <sup>2</sup>
	Fallhöhe	180 cm
	schwerstes Element	620 kg
	grösstes Element	505 x 170 x 240 cm
	Fundamente	22
	Beton	3.3 m <sup>3</sup>
	Montagezeit	8 h
	Monteure	3

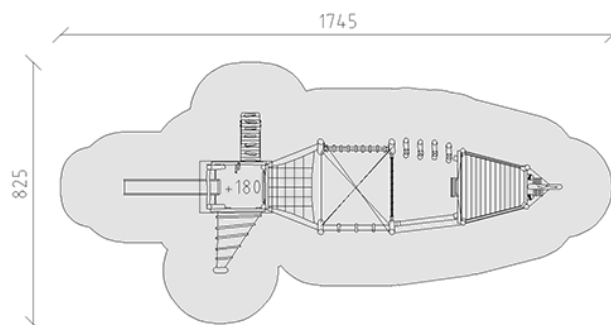

**buerli**  
Mitten im Spiel

+41 41 925 14 00  
info@buerli.swiss