

# Vogelnest- und Dschungelschaukel

Gerätelinie Stahl











Artikel 62807

Vogelnest- und Dschungelschaukel aus Stahlrohr feuerverzinkt, Aufhängevorrichtungen aus Edelstahl, mit Vogelnest Huck  $\varnothing$  125 cm, Seilringfarbe blau und Dschungelsitz aus 4-kant geflochtenem Seil, 15 x 15 cm, minimale Einbautiefe 50 cm.



**CHF 6'530.-**

(exkl. MWST)

 Altersgruppe	3+
 Gerätemasse	608 x 198 x 269 cm
 Platzbedarf	831 x 608 cm
 min. Aufprallfläche	33.5 m <sup>2</sup>
 Fallhöhe	202 cm
 schwerstes Element	50 kg
 grösstes Element	315 x 8 x 245 cm
 Fundamente	6
 Beton	1.1 m <sup>3</sup>
 Montagezeit	3 h
 Monteure	2

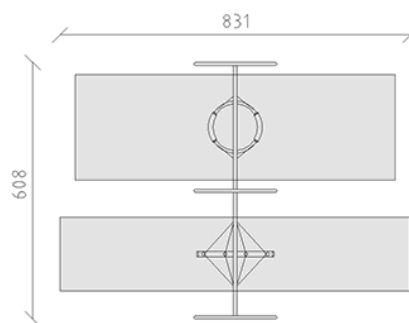

**buerli**  
Mitten im Spiel

+41 41 925 14 00

info@buerli.swiss