

Construction de balançoire avec nid d'oiseau

Ligne du dispositif Robinie











Article 40182

Construction de balançoire en bois de robinier meulé et chimique non traité, dispositifs de suspension en acier inoxydable pour deux sièges, poutre horizontale et joints angulaires en acier galvanisé à chaud, avec nid d'oiseau d'Huck Ø 125 cm, corde en couleur beige.



CHF 5'550.-

(hors TVA)

	Groupe d'âge	3+
	Dimensions de l'appareil	653 x 230 x 272 cm
	Espace requis	795 x 653 cm
	Surface d'impact	41.85 m ²
	Hauteur de chute	146 cm
	l'élément le plus lourd	60 kg
	Le plus grand élément	370 x 16 x 16 cm
	Fondations	6
	Béton	1.2 m ³
	Temps de montage	3 h
	Monteurs	2

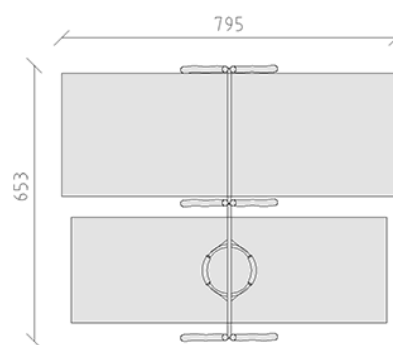

buerli
Au coeur du jeu