

# Swing frame with Bird's Nest

Device line Robinie











Article 40176

Swing frame with bird's nest made of chemically untreated robinia heartwood, sanded, stainless steel suspension device for one seat, corner connectors hot-dip galvanised and additionally lacquered in RAL 7016, with Bird's Nest Huck ø 125 cm, beige rope ring.



**CHF 6'145.-**

(excl. VAT)

 Age group	3+
 Device dimensions	608 x 225 x 275 cm
 Space required	790 x 608 cm
 min. impact surface	32.5 m <sup>2</sup>
 Fall height	146 cm
 Heaviest element	60 kg
 Biggest element	370 x 16 x 16 cm
 Foundations	6
 Concrete	0.8 m <sup>3</sup>
 Assembly time	3 h
 Installers	2

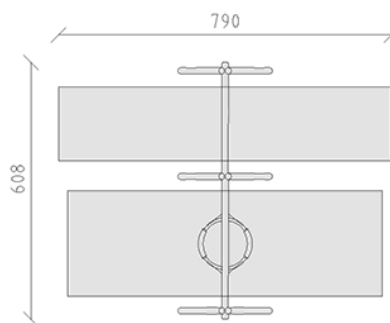

**buerli**  
Center of play

+41 41 925 14 00

info@buerli.swiss