

Play tower combination Eco/aluminium

Device line Aluminium







Article 55110

Play tower combination made of multi-glued Swiss pine, pressure-treated, posts made of stove-enamelled aluminium, colour anthracite, platform height 150 cm, with saddle roof, slide made of polyester green/green, tree trunk access, vertical net and access steps, minimum installation depth 50 cm.



CHF 8'725.-

(excl. VAT)

	Age group	3+
	Device dimensions	411 x 371 x 340 cm
	Space required	720 x 712 cm
	min. impact surface	33.3 m ²
	Fall height	150 cm
	Heaviest element	150 kg
	Biggest element	340 x 145 x 120 cm
	Foundations	9
	Concrete	0.8 m ³
	Assembly time	3 h
	Installers	2

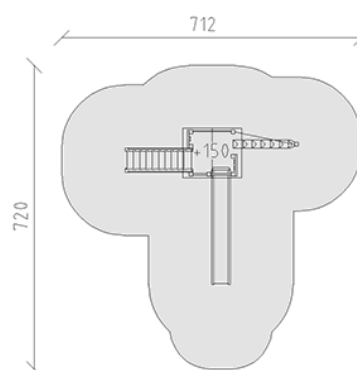

berli
Center of play