

Swing frame combination

Device line Stahl











Article 61500

Swing frame combination made of hot-dip galvanised tubular steel, stainless steel suspension devices for one seat, with laterally attached slide made of blue polyester, minimum installation depth 50 cm.



CHF 3'590.-

(excl. VAT)

 Age group	3+
 Device dimensions	412 x 350 x 234 cm
 Space required	829 x 562 cm
 min. impact surface	35.3 m ²
 Fall height	125 cm
 Heaviest element	75 kg
 Biggest element	280 x 60 x 230 cm
 Foundations	6
 Concrete	1.1 m ³
 Assembly time	4 h
 Installers	2

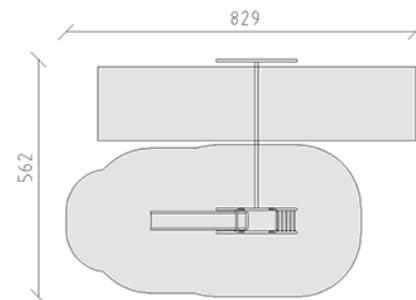

buerli
Center of play