

Playtower combination

Device line Rundholz











Article 28720

Playtower combination made of multi-glued Swiss pine, pressure impregnated, platform heights 150/180 cm, with pyramid roof, ribbed access ladder, stainless steel climbing pole, suspension bridge, slide made of polyester red/yellow, tree trunk access ladder, incl. steel foot brackets for minimum installation depth 50 cm.



CHF 16'340.-

(excl. VAT)

	Age group	3+
	Device dimensions	592 x 553 x 389 cm
	Space required	912 x 903 cm
	min. impact surface	54.95 m ²
	Fall height	180 cm
	Heaviest element	274 kg
	Biggest element	180 x 180 x 389 cm
	Foundations	15
	Concrete	1.8 m ³
	Assembly time	4 h
	Installers	2

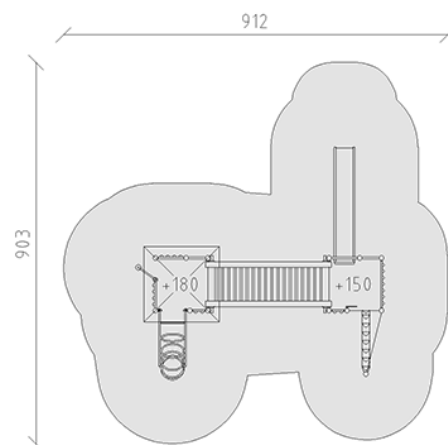

buerli
Center of play

+41 41 925 14 00

info@buerli.swiss