

Playtower combination

Device line Eco











Article 54270

Playtower combination made of multi-glued Swiss pine, pressure impregnated, platform height 150 cm, with gable roof, rung ascent, ascending stairs, climbing wall, bent metal ladder and slide made of polyester red/yellow, incl. steel foot bracket for minimum installation depth 50 cm.



CHF 7'995.-

(excl. VAT)

	Age group	3+
	Device dimensions	376 x 371 x 340 cm
	Space required	721 x 678 cm
	min. impact surface	33.8 m ²
	Fall height	150 cm
	Heaviest element	160 kg
	Biggest element	118 x 145 x 340 cm
	Foundations	10
	Concrete	1 m ³
	Assembly time	5 h
	Installers	2

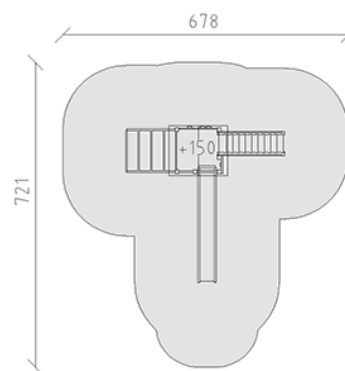

buerli
Center of play