

Playtower combination

Device line Eco











Article 54610

Playtower combination made of multi-glued Swiss pine, pressure impregnated, platform heights 120/150 cm, with gable roof, rung ascent, climbing wall, climbing net ascent, inclined ramp, slide made of polyester red/yellow, swing section made of hot-dip galvanised tubular steel, stainless steel suspension device for two seats, incl. steel foot brackets for minimum installation depth 50 cm.



CHF 10'550.-

(excl. VAT)

	Age group	3+
	Device dimensions	837 x 482 x 340 cm
	Space required	1037 x 835 cm
	min. impact surface	60.75 m ²
	Fall height	150 cm
	Heaviest element	230 kg
	Biggest element	118 x 233 x 340 cm
	Foundations	14
	Concrete	1.7 m ³
	Assembly time	5 h
	Installers	2

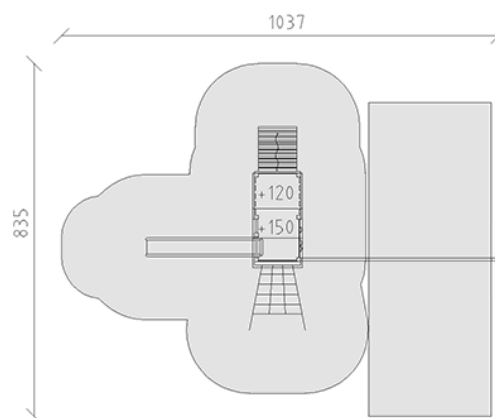

berli
Center of play