

nicht vermasste Radien bei Aufprallfläche R1500
 Espace de chute avec radius sans
 indication de mesures R1500

Fundament F01-R

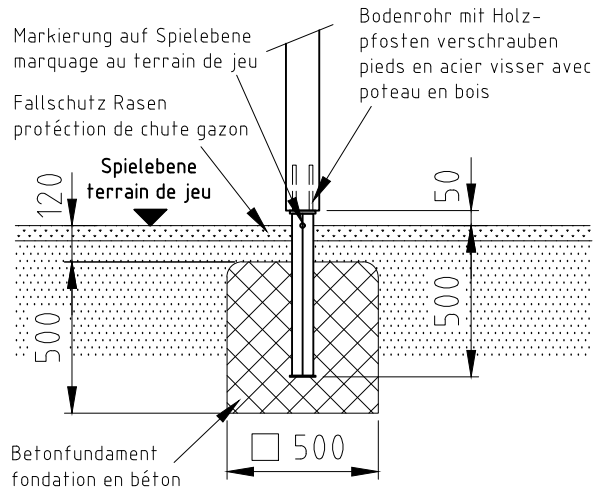

Fundament F09-R

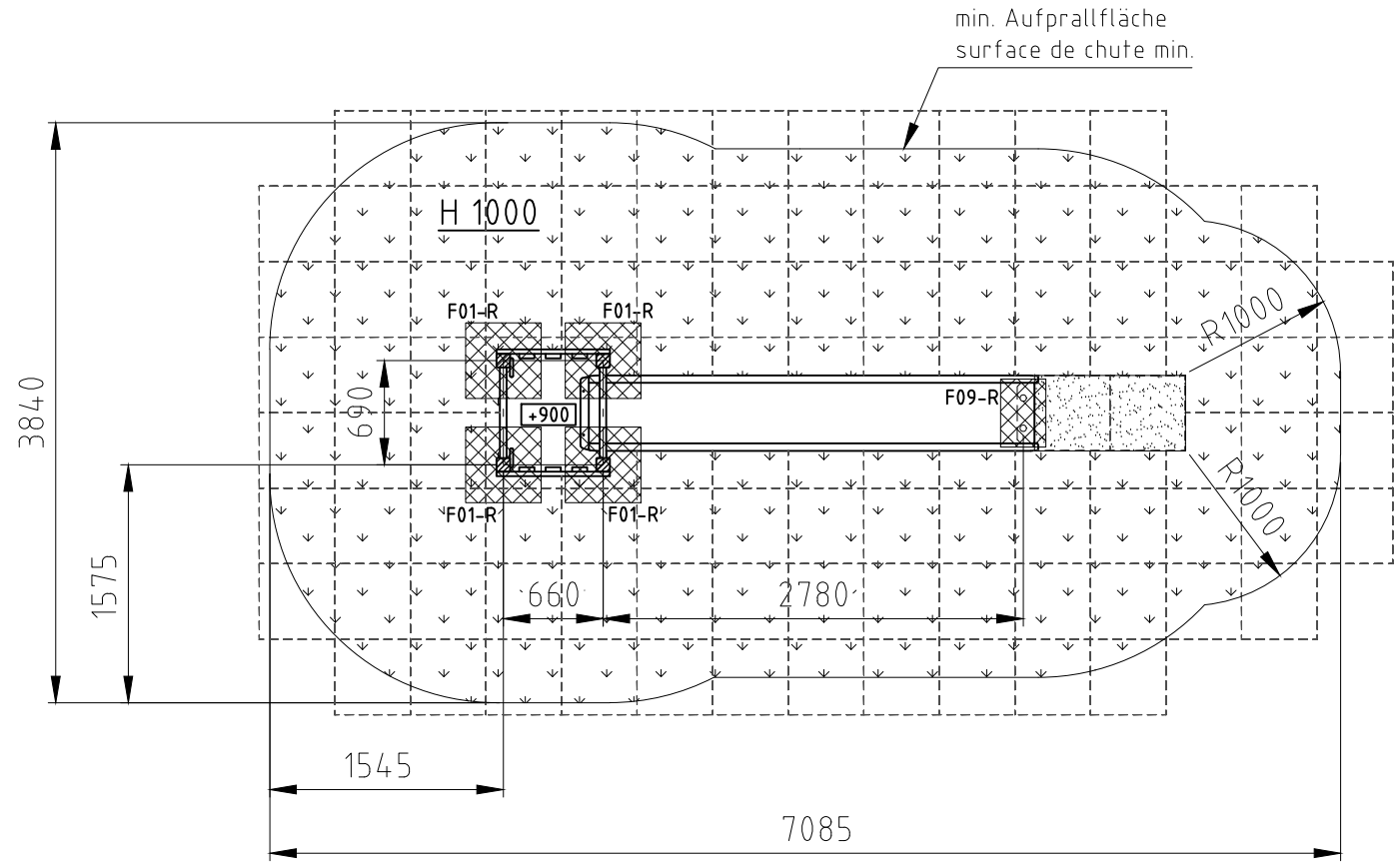
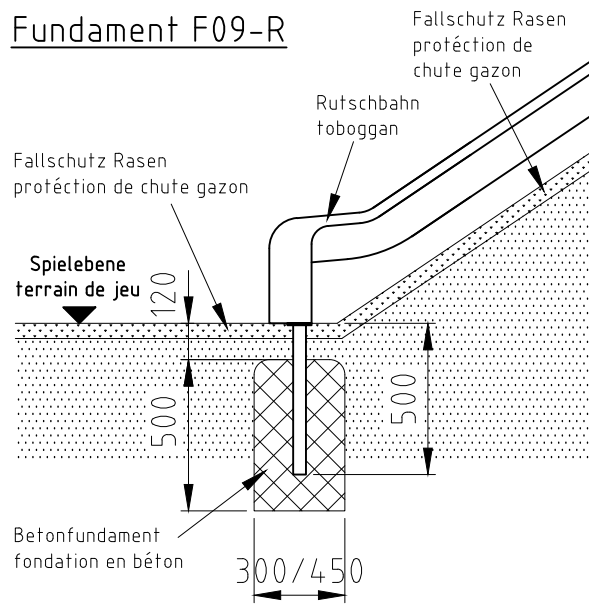

H= Fallhöhe
 H= espace de chute

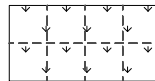

Aufprallfläche 0-100cm
 espace de chute 0-100cm

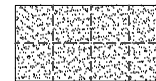

Aufprallfläche 0-150cm
 espace de chute 0-150cm

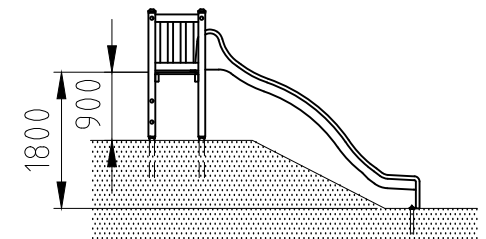

Norm: SN EN 1176-1:2018 SN EN 1177:2018	Datum	Name	Objekt: 10500-001-r Wellen-Rutschbahn mit Mini-Turm PH180	Fundation
	Gez	sa		
	Sachbearbeiter		Auftraggeber: Fallschutz Rasen / protéction de chute gazon	M: 1:50
 Spiel- und Sportgeräte AG CH-6212 St. Erhard Tel 041 925 14 00 info@buerli.swiss			Offerte/Auftrag:	Layout: 1 A4q
			Zeichn-Nr.: 011775.dwg	Index: C

© by www.buerli.swiss